



info@allianceplast.com

+371 28 664 102

Lubanas str. 125a-18, Riga, LV-1021, Latvia

www.allianceplast.com



**Shape:** ROUND  
**Volume:** 400 ml  
**External diameter top with lid:** 140,8mm  
**External diameter bottom:** 126,5 mm  
**External diameter lid:** 139,7 mm  
**Height container with lid:** 40,6 mm  
**Height lid:** 7,4 mm  
**Weight container:** 17,6 g  
**Weight standard lid:** 10,2 g  
**Weight standard handle:** N/A g



ARTICLE: AL140/04



**Closure type:** Snap-On  
**Protective collar:** Yes

**Tamper Evidence type:** Slider  
**Lid type options:** Standard



OPEN



**Handle available:** None

Different IML options

Perfect colour matching

Full cover

Peek inside  
Create a transparent  
pot window

Perfect mix  
Clear pot with colourful  
lid. Or vice versa

Coloured  
plastic options

Choose from Pantone  
or mixed CMYK  
colour palettes



**Decoration available:** IML  
**Container:** By request  
**Lid:** Yes



**Raw material options:** PP random QU 80 A (MFI 35), Braskem (MFI 40), Borealis RJ377MO Random, Moplen RP348T, Borealis BD950MO Freezgrade (Transparent).

**Masterbatch colors:** Preferred colours: White 101, Clear, Natural, Blue 201, Dark Blue 204, Black 601, Light Grey 502, Red 331, Yellow 430 and Green 803. Additional colours: Transparent Red 338, Silver 521, Gold 21720, Warm Red 307, Warm Yellow 417, Beige 421, Brown 901, Dark Grey 501 (metal grey), Orange 741 and Blue 213. All other colours on request.



**Approvals:** All products comply with the FDA and European legislation in force relating to materials and articles intended to come into contact with food.



**Stackability, filled:** kg (=max weight on bottom container)  
 The stacking tests have been performed with the standard raw material as stated above at 23° C over a period of 2 months. Stackability depends on many factors and the above data is meant as an indication only. Consequently, customers should make internal trials to determine the viability of free-standing stacking and transportation. Notably, transparent (CLX) materials are softer than standard material, hence stacking must be considered when contact clear materials are chosen.



**Total Pcs. Per BOX**

**Total Pcs. Per PALETTE**

**Boxes Per Palette**

**Total Palette Height**

	LIDS + CUPS	CUPS	LIDS	LIDS + CUPS	CUPS	LIDS	LIDS + CUPS	CUPS	LIDS
Total Pcs. Per BOX	174	-	560	290	408	1020	384	560	-
Total Pcs. Per PALETTE	5568/6960	-	17920/22400	5800/6960	8160/9792	20400/24480	6144/6912	8960/10080	-
Boxes Per Palette	32 / 40	32 / 40	32 / 40	20 / 24	20 / 24	20 / 24	16 / 18	16 / 18	16 / 18
Total Palette Height	215 / 265 cm	215 / 265 cm	215 / 265 cm	215 / 255 cm	215 / 255 cm	215 / 255 cm	223 / 263 cm	223 / 263 cm	223 / 263 cm
	BOX 25 / EPAL 25 (Reference page 2)			BOX 40 / EPAL 40 (Reference page 2)			BOX 52 / EPAL 52 (Reference page 2)		



**Hot filling:** 85–95° C  
 The material chosen has a very good heat resistance and the packaging is suitable for hot filling. Notably, plastic packaging become flexible when subjected to hot filling temperatures and care must be taken in relation to stacking immediately after hot filling.  
 After cooling of the product and pail, the pail regains its original stacking strength.



**Cold temperatures:** The standard resin material for white/coloured products resists temperatures down to -20° C. Deep freezing below -20° C may require a special resin available on request. Standard transparent (CLX) products might become brittle at temperatures below 0° C, and special resins are available on request for applications below freezing. Resins tailored for freezing stability has a lower stackability than standard resin which must be taken into consideration.



**Special:** Microwave safe  
**Shelf life:** The compliance of the product to the technical specifications in this data sheet is guaranteed for 12 months after the date of the delivery subject to suitable storage.



**Quality information:** Deviations in the product specifications in this data sheet of 0.025% or less (i.e. 25 items per 100,000) on a rolling 12 months basis are considered acceptable in the industry and therefore cannot be construed as a defect. Also, please refer to the Standard Sales and Delivery Terms in force at the time of delivery.



**UN approval:** No



# ALLIANCE PLAST

## TECHNICAL DATA SHEET

✉ info@allianceplast.com

☎ +371 28 664 102

📍 Lubanas str. 125a-18, Riga, LV-1021, Latvia

🌐 www.allianceplast.com

### LABEL PRINT AREA

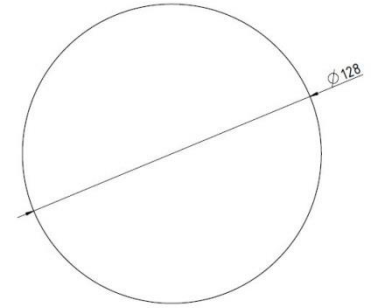
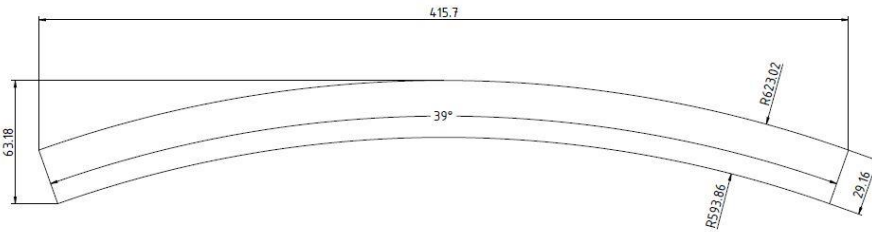

### DIMMENSIONS

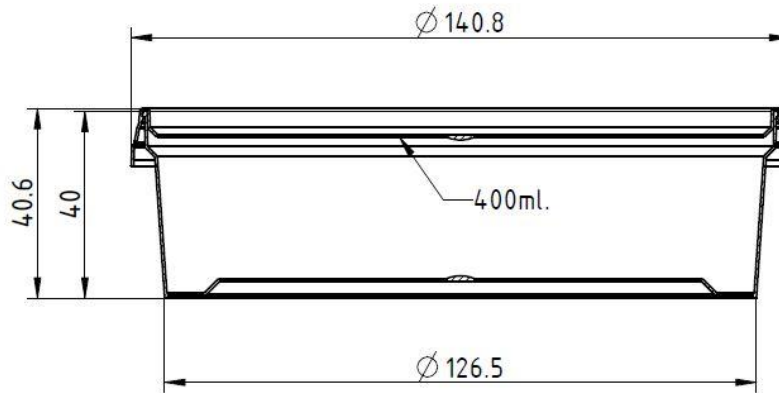
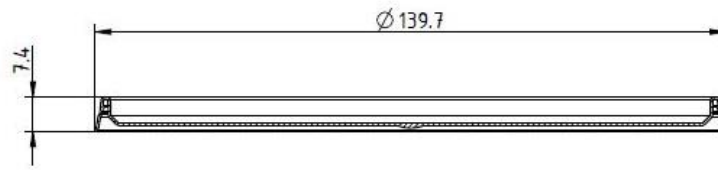

### PALLETIZATION

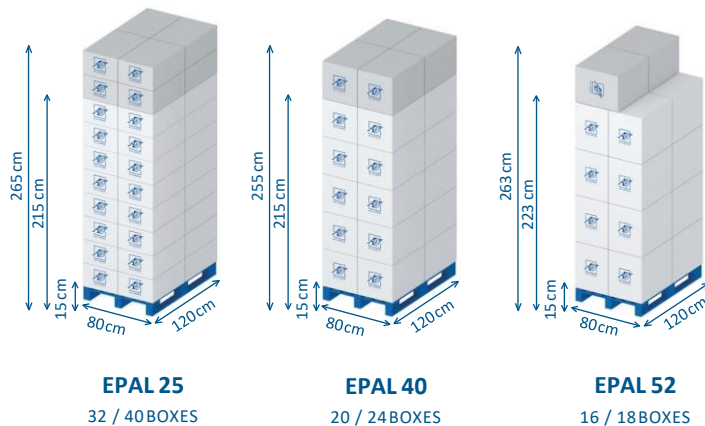
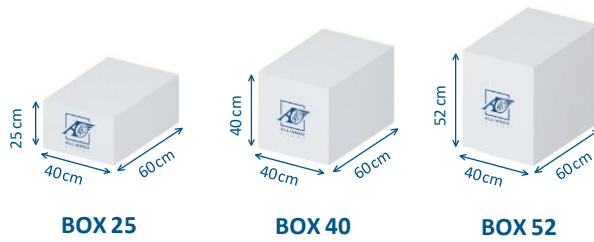

### STICKER ON THE BOX

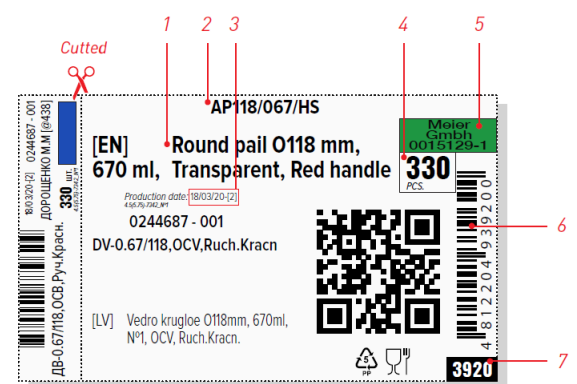

1. Description (Eng)
2. Article (Eng)
3. Production date
4. Pieces per BOX
5. Customer and Order nr.
6. Customer Order Defined EAN-13 Barcode
7. Article Code (4 digit)