



<b>Shape:</b>	ROUND
<b>Volume:</b>	1550 ml
<b>External diameter top with lid:</b>	173mm
<b>External diameter bottom:</b>	148,1mm
<b>External diameter lid:</b>	170 mm
<b>Height container with lid:</b>	91 mm
<b>Height lid:</b>	6,9 mm
<b>Weight container:</b>	47 g
<b>Weight standard lid:</b>	17,2 g
<b>Weight standard handle:</b>	3,2 g



ARTICLE: **AL170/1,5/H**



<b>Closure type:</b>	Snap-On	<b>Tamper Evidence type:</b>	Standard
<b>Protective collar:</b>	Yes	<b>Lid type options:</b>	Standard



**Handle available:** Plastic

Different IML options

Perfect colour matching



<b>Decoration available:</b>	IML
<b>Container</b>	Yes
<b>Lid</b>	Yes

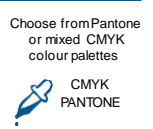

**Raw material options:** PP random QU 80 A (MFI 35), Braskem (MFI 40), Borealis RJ377MO Random, Moplen RP348T, Borealis BD950MO Freezgrade (Transparent).



**Masterbatch colors:** Preferred colours: White 101, Clear, Natural, Blue 201, Dark Blue 204, Black 601, Light Grey 502, Red 331, Yellow 430 and Green 803. Additional colours: Transparent Red 338, Silver 521, Gold 21720, Warm Red 307, Warm Yellow 417, Beige 421, Brown 901, Dark Grey 501 (metal grey), Orange 741 and Blue 213. All other colours on request.



**Approvals:** All products comply with the FDA and European legislation in force relating to materials and articles intended to come into contact with food.



**Stackability, filled:** kg (=max weight on bottom container)  
The stacking tests have been performed with the standard raw material as stated above at 23° C over a period of 2 months. Stackability depends on many factors and the above data is meant as an indication only. Consequently, customers should make internal trials to determine the viability of free-standing stacking and transportation. Notably, transparent (CLX) materials are softer than standard material, hence stacking must be considered when contact clear materials are chosen.



	LIDS + CUPS	CUPS	LIDS	LIDS + CUPS	CUPS	LIDS	LIDS + CUPS	CUPS	LIDS
<b>Total Pcs. Per BOX</b>	60	-	330	90	105	540	156	180	-
<b>Total Pcs. Per PALETTE</b>	1920/2400	-	10560/13200	1800/2160	2100/2520	10800/12960	2496/2808	2880/3240	-
<b>Boxes Per Palette</b>	32 / 40	32 / 40	32 / 40	20 / 24	20 / 24	20 / 24	16 / 18	16 / 18	16 / 18
<b>Total Palette Height</b>	215 / 265 cm	215 / 265 cm	215 / 265 cm	215 / 255 cm	215 / 255 cm	215 / 255 cm	223 / 263 cm	223 / 263 cm	223 / 263 cm
	BOX 25 / EPAL 25 (Reference page 2)			BOX 40 / EPAL 40 (Reference page 2)			BOX 52 / EPAL 52 (Reference page 2)		



**Hot filling:** 85–95° C  
The material chosen has a very good heat resistance and the packaging is suitable for hot filling. Notably, plastic packaging become flexible when subjected to hot filling temperatures and care must be taken in relation to stacking immediately after hot filling.  
After cooling of the product and pail, the pail regains its original stacking strength.



**Cold temperatures:** The standard resin material for white/coloured products resists temperatures down to -20° C. Deep freezing below -20° C may require a special resin available on request. Standard transparent (CLX) products might become brittle at temperatures below 0° C, and special resins are available on request for applications below freezing. Resins tailored for freezing stability has a lower stackability than standard resin which must be taken into consideration.



**Special:** Microwave safe



**Shelf life:** The compliance of the product to the technical specifications in this data sheet is guaranteed for 12 months after the date of the delivery subject to suitable storage.



**Quality information:** Deviations in the product specifications in this data sheet of 0.025% or less (i.e. 25 items per 100,000) on a rolling 12 months basis are considered acceptable in the industry and therefore cannot be construed as a defect. Also, please refer to the Standard Sales and Delivery Terms in force at the time of delivery.



**UN approval:** No



# ALLIANCE PLAST

## TECHNICAL DATA SHEET

✉ info@allianceplast.com

☎ +371 28 664 102

📍 Lubanas str. 125a-18, Riga, LV-1021, Latvia

🌐 www.allianceplast.com

### LABEL PRINT AREA

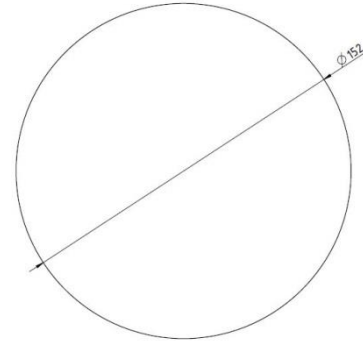
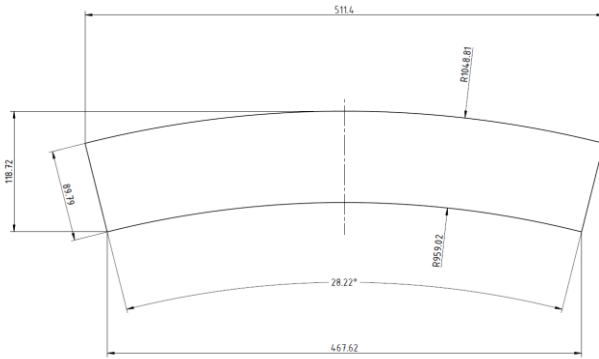

### DIMENSIONS

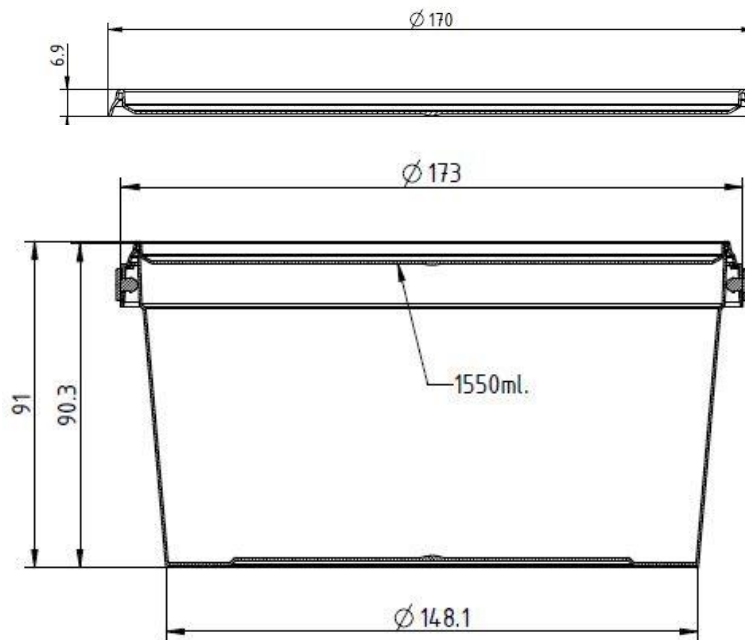

### PALLETIZATION

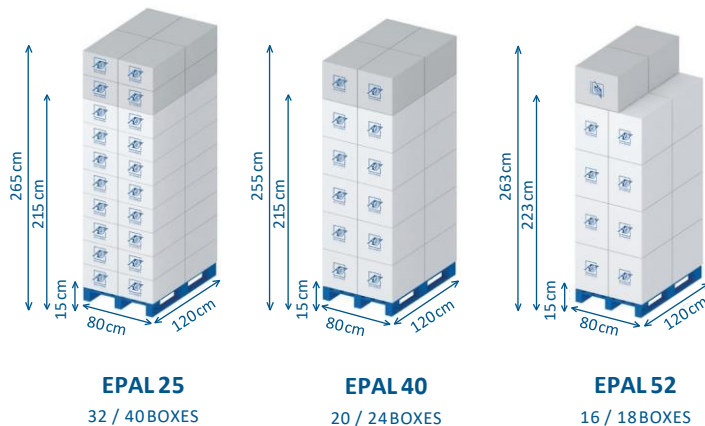
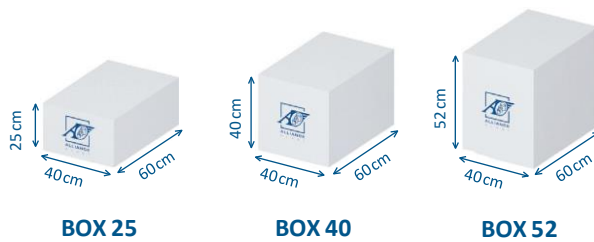

### STICKER ON THE BOX

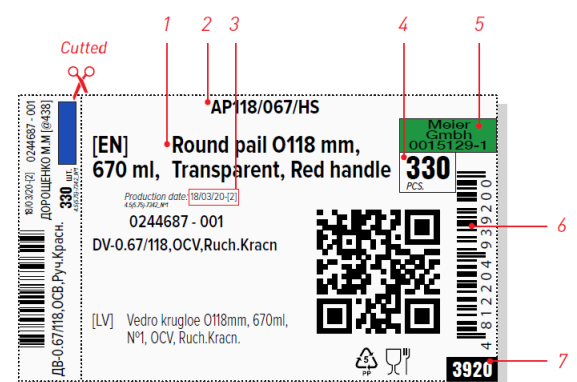

1. Description (Eng)
2. Article (Eng)
3. Production date
4. Pieces per BOX
5. Customer and Order nr.
6. Customer Order Defined EAN-13 Barcode
7. Article Code (4 digit)